

# CLIP

FICHA TÉCNICA *TECHNICAL DETAILS*

# CLIP

O Clip é um sistema de revestimento de fachadas em ripado, passível de ser aplicado horizontal ou verticalmente, que através de um número reduzido de perfis permite múltiplas soluções de arquitetura de fixação a fachadas e tetos. Trata-se de um sistema simples, versátil e compatível com qualquer outro elemento de fachada, designadamente portas e janelas. Pode ser customizado em qualquer cor e acabamento para o enquadramento perfeito com restantes sistemas ou outros elementos do projeto de arquitetura.

- Versatilidade de aplicação
- Instalação simples e rápida
- Cuidados de manutenção simples
- Contribui para menor consumo de energia

Clip is a slatted façade cladding system, which can be applied horizontally or vertically, using a reduced number of profiles to provide multiple architectural solutions for fixing to façades and ceilings.

It is a simple, versatile system that is compatible with any other façade element, such as doors and windows. It can be customized in any color and finishing to fit in perfectly with other systems or other elements of the architectural project.

- Versatility of application
- Simple and quick installation
- Simple maintenance
- Contributes to lower energy consumption

## CLIP 20

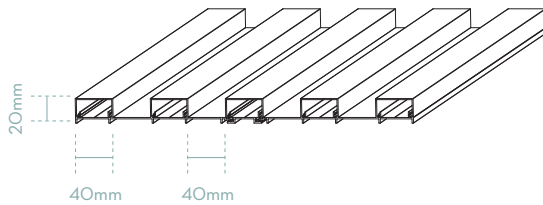

## CLIP 20XL

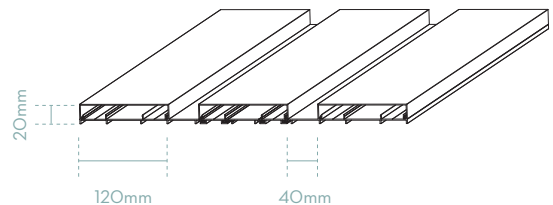

## CLIP 40

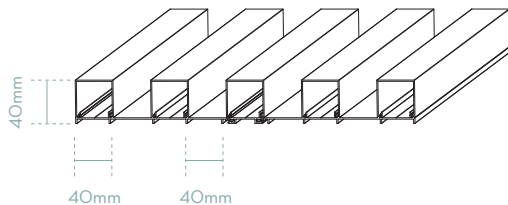

## CLIP 40U

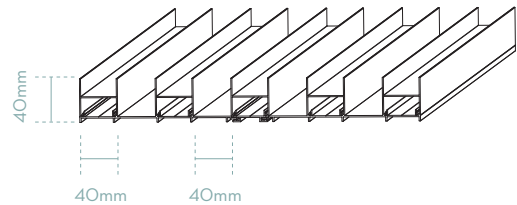

## CLIP 80

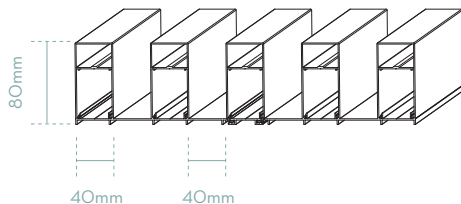

## CLIP 120

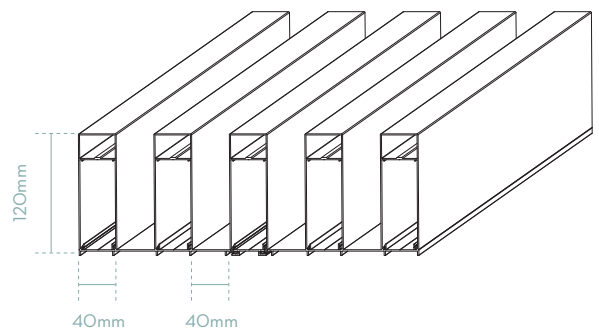

## CLIP MIX

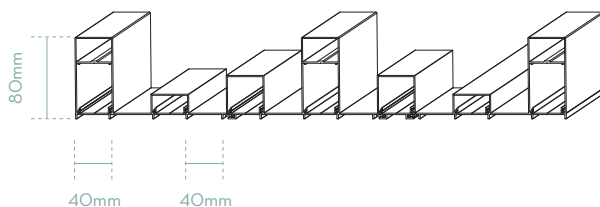



CLIP Divisão de espaços | *CLIP Space division*



CLIP com transparência | *CLIP with transparency*



CLIP Revestimento de fachadas | *CLIP Façade cladding*



Take the most of it

Rua dos Combatentes, 603 A  
4485-093 Fajozes  
Vila do Conde, Portugal

[www.vview.pt](http://www.vview.pt)